

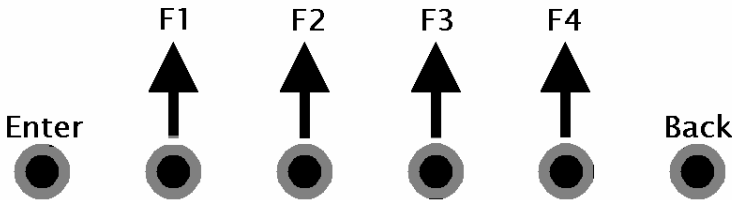

Elnet^{LTC} Energy & Power quality
www.ddc.co.il

DATA SCREEN					
MONTH-AVARAGE		0.920			
WEEK-AVARAGE		0.920			
PF		0.927			
1	2	3	4	5	6
OFF	OFF	OFF	ON	OFF	ON



Elnet LTC



Power Factor Controller

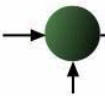
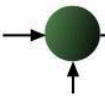

Table of Contents

CHAPTER 1 – Electrical Wiring.....	3
1.1 Electrical Wiring.....	3
1.2 Electrical Connections.....	4
CHAPTER 2 – Power Factor Controller.....	8
2.1 Data Screen.....	9
2.2 Vital Settings.....	10
2.3 Non Vital Settings.....	13
2.4 Working Range.....	14



CHAPTER 1 – Electrical Wiring

1.1 Electrical Wiring

Notice!
The distance between the external current transformer and the Elnet will not exceed 5m

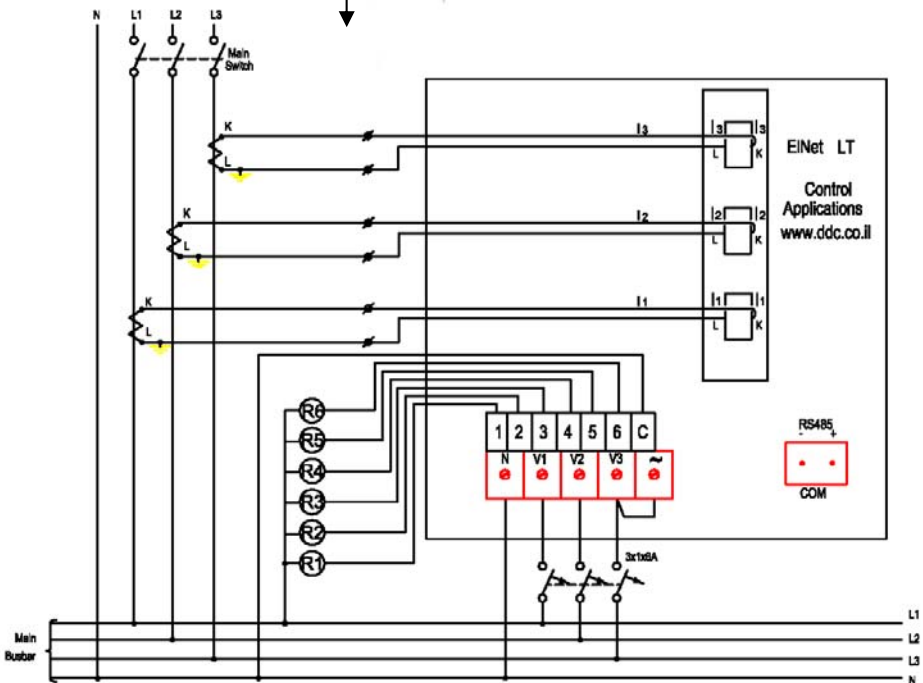

Attention! Maximum current for relays R1 – R6 is up to **150ma MAX**

Figure 1.1 – Electrical wiring diagram

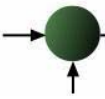

1.2 Electrical connections

All Connections, except those to the CT core of the *ElNet* LTC Energy & Power Factor Controller are made via terminal connector plugs (Voltage input, Power Supply, Communication etc.).

Recommended max tightening torque for the connector screws is 0.5 Nm.

The CT cores of the *ElNet* LTC Energy & Power Factor Controller are located externally on the rear of the instrument and the lead from the leg of the external Current Transformer must pass through in the correct direction.

NOTE!

Ensure all the connections to the leads of the current transformer wiring are secure and there is no mechanical strain on the wire. The cross section of the leads to the Current transformer must be compatible with the power of the current transformer. We recommend a power transformer with at least 3VA and the length of the wiring of the transformer should not exceed 3m.

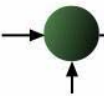

Insert the lead from side “L” of the Current Transformers of Line 1 through the bottom of the CT core I1A, (top left looking from back), of the *ElNet* LTC Energy & Power Factor Controller.

- Ensure the leads from leg “L” of the Current Transformer on **Line 1** pass through the bottom of CT core I1A.
- Ensure the other end of the lead emerging from the top of CT core I1A is connected to leg “K” of the external Current Transformer on **Line 1**.

WARNING!

Never allow an open circuit between the two Current Transformers.

Repeat the procedure for Line 2 and Line 3.

Connect the rest of the connections to the *ElNet* LTC Energy & Power Factor Controller by means of terminal connector plugs.

All Rear Panel connections are according to the wiring diagram (See Figure 1.1) and are easy to follow.

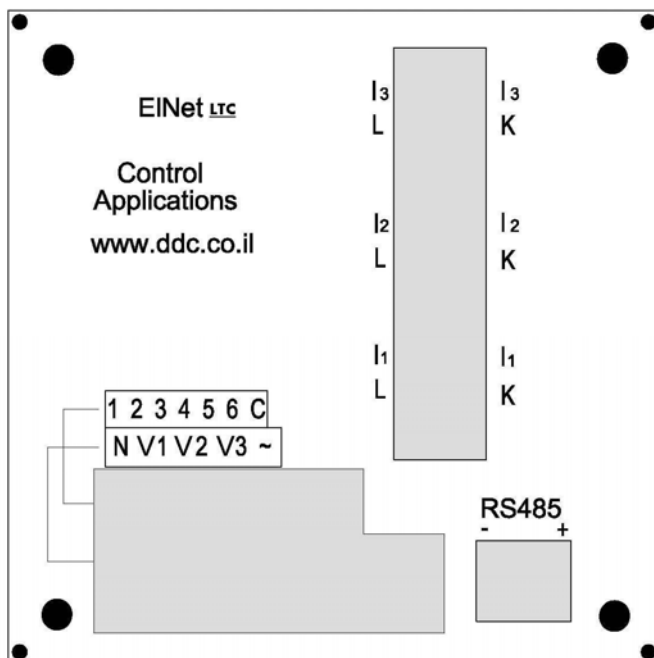
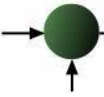

Figure 1.2 – Back of the device

Pin Designation	Description	Remarks
V₁	Line 1 - Voltage Supply	Use 6Amp fuse to protect the line
V₂	Line 2 - Voltage Supply	Use 6Amp fuse to protect the line
V₃	Line 3 - Voltage Supply	Use 6Amp fuse to protect the line
I_{1A}	From external Current Transformer on Line1	Note the correct direction to insert the lead
I_{2A}	From external Current Transformer on Line2	Note the correct direction to insert the lead
I_{3A}	From external Current Transformer on Line3	Note the correct direction to insert the lead
L	Power 80 - 280 VAC	OR 110-300 VDC
N	Neutral	Bridged from the neutral Line
R1 - R6	Control relay outputs	up to 150mA max
C	Common connector for the control relays outputs	
RS-485 - (-)	Communications	
RS-485 - (+)		

Figure 1.3 – Connections on the back of the device



CHAPTER 2 – Power Factor Controller

EInet LTC Energy & Power Factor Controller enables measurement of power factor and power factor correction by using ON/OFF switching control of capacitors.

Elnet LTC enables automatic identification of capacitors' size and its connection in various methods.

1. In the Main Menu select "power, power factor" and press Enter.
2. Select "PF Controller". The following screen will appear:

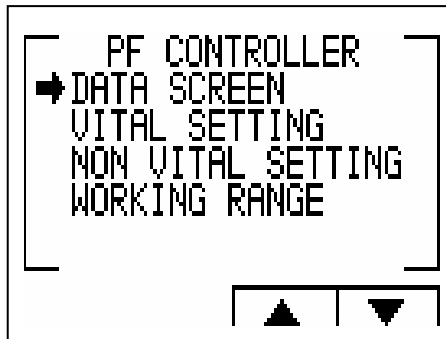
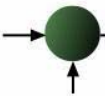

Figure 2.1 – PF Screen



2.1 Data Screen

Selection of "Data Screen" displays monthly and weekly average power factor and also real time power factor. In addition, at the bottom line you can see which capacitors are connected and which ones are disconnected.

In case of fault one of the following messages will appear: "Low Current", "High THD", "Volt Range Error", "Capacity Load", and "Need More Capacitors".

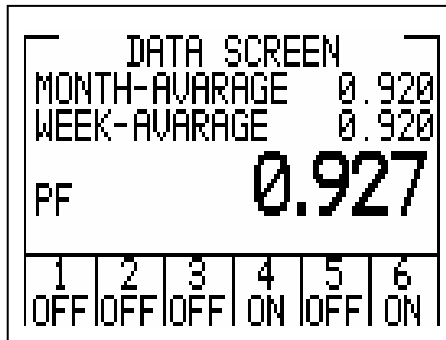
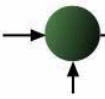

Figure 2.2 – Data Screen



2.2 Vital Settings

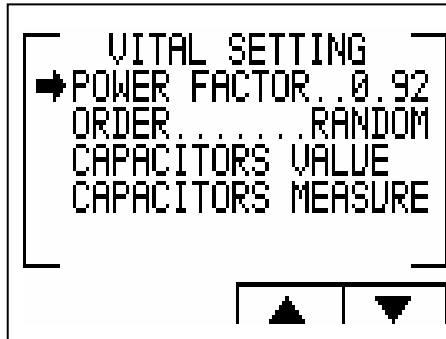

Figure 2.3 – Vital Settings

Setting power factor

Pressing Enter at the line indicating "power factor" enables setting the requested power factor. When selecting this option a screen will appear displaying the power factor, a changeable number. By the means of arrow buttons select the desirable digit and by +/- buttons change the value of the number.

Changing the connection order (capacitors)

Each time you press Enter at the line indicating "connection order" the connection order options will be changed from the following possibilities: random, first, cycle.

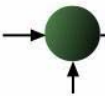

The capacitors chosen for power factor correction are chosen according to their size, meaning that it is chosen the minimal number of the capacitors for achieving the requested value of the power factor.

There are a number of methods as following:

Random - this method enables random selection of equally-sized capacitors. In this method after a certain period the number of working hours of all equally-sized capacitors will be equal.

First - this method enables fixed selection, meaning a certain capacitor will always be first and the other will always be second and so on – this method is recommended in places preferring unequal working hours of the capacitors.

Cycle - whenever there are a few capacitors of equal size there is a possibility to use the "cycle" method so that the number of working hours will be equally divided between these capacitors.

Capacitors' value setting:

Press Enter at the line indicating "capacitors value".

Capacitors 1 – 6 will be displayed; pressing Enter on the requested capacitor will show a screen enabling the setting of capacitor's size.

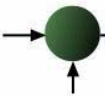

Capacitors' value measure:

VALUE	MEASURE	CAP
1.000	0.825	1 ←
1.000	----	2
1.000	----	3
2.000	----	4
2.000	----	5
3.000	----	6

MSSR.

Figure 2.4 – Value measure of the capacitors

The Multimeter enables true capacitors value measure for capacitors 1 – 6. At the column "Measure" indicated the measured value and at the column "Value" indicated the capacitor's value as defined by the user.

The "Rnd" button enables correction of the measured values to the closest rounded value under the condition that the difference between the capacitors doesn't exceed 10%.

The "Save" button enables saving the measured (and/or rounded) values instead of the values entered by the user at the previous screen "capacitors value".

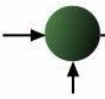

2.3 Non-vital settings

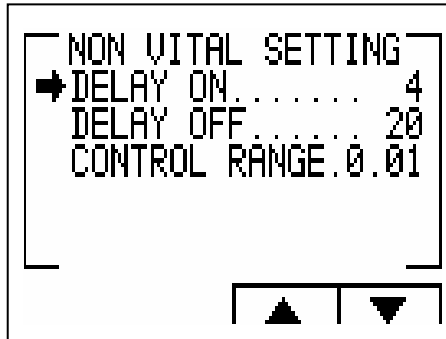
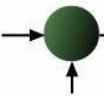

Figure 2.5 – Non – vital settings

At the above screen there are a few non-vital settings that may be changed by the user detailed as following:

"Delay On": enables setting the delay between the decision of connecting the capacitor and its actual connection. This delay is meant to minimize the number of connections/disconnections of the capacitors during control of the desired power factor value.

"Delay Off": enables setting the delay between the decision of disconnecting the capacitor and its actual disconnection. This delay is meant to minimize the number of connections/disconnections of the capacitors during control of the desired power factor value.



"Control Range": enables the user to define the working range of the capacitors in performing power factor correction. When the "control range" = 0.01 the system is looking for the minimal capacitors number for performing power factor correction from the desired value (for example, 0.92) to the value $0.93 = 0.92 + 0.01$ (control range). From this point, the system is looking for the minimal capacitors' combination required for reaching power factor of 0.93 and is disconnecting capacitors accordingly.

The setting is made by selecting the digit with ← → and changing the value by (+), (-).

2.4 Working range settings

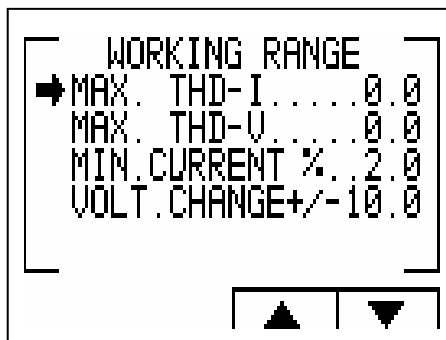
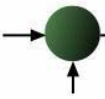

Figure 2.6 – Working range settings



Working range settings enable defining ranges for current, voltage, THD V and THD I values detailed as following:

"Max. THD I" setting enables disconnection of all the capacitors whenever the actual THD I value exceeds the value which was defined by the user. If THD I = 0 this option is unavailable.

"Max. THD V" setting enables disconnection of all the capacitors whenever the actual THD V value exceeds the value which was defined by the user. If THD V = 0 this option is unavailable.

"Min. current" setting enables defining value for minimal current under which power factor correction is not required.

"Volt. Change" setting enables defining low/high voltage range above which the Elnet LTC disconnects all the capacitors.

The setting is made by selecting the digit with ← → and changing the value by (+), (-).